

Beim Drucken „Seitenanpassung: keine“ auswählen.

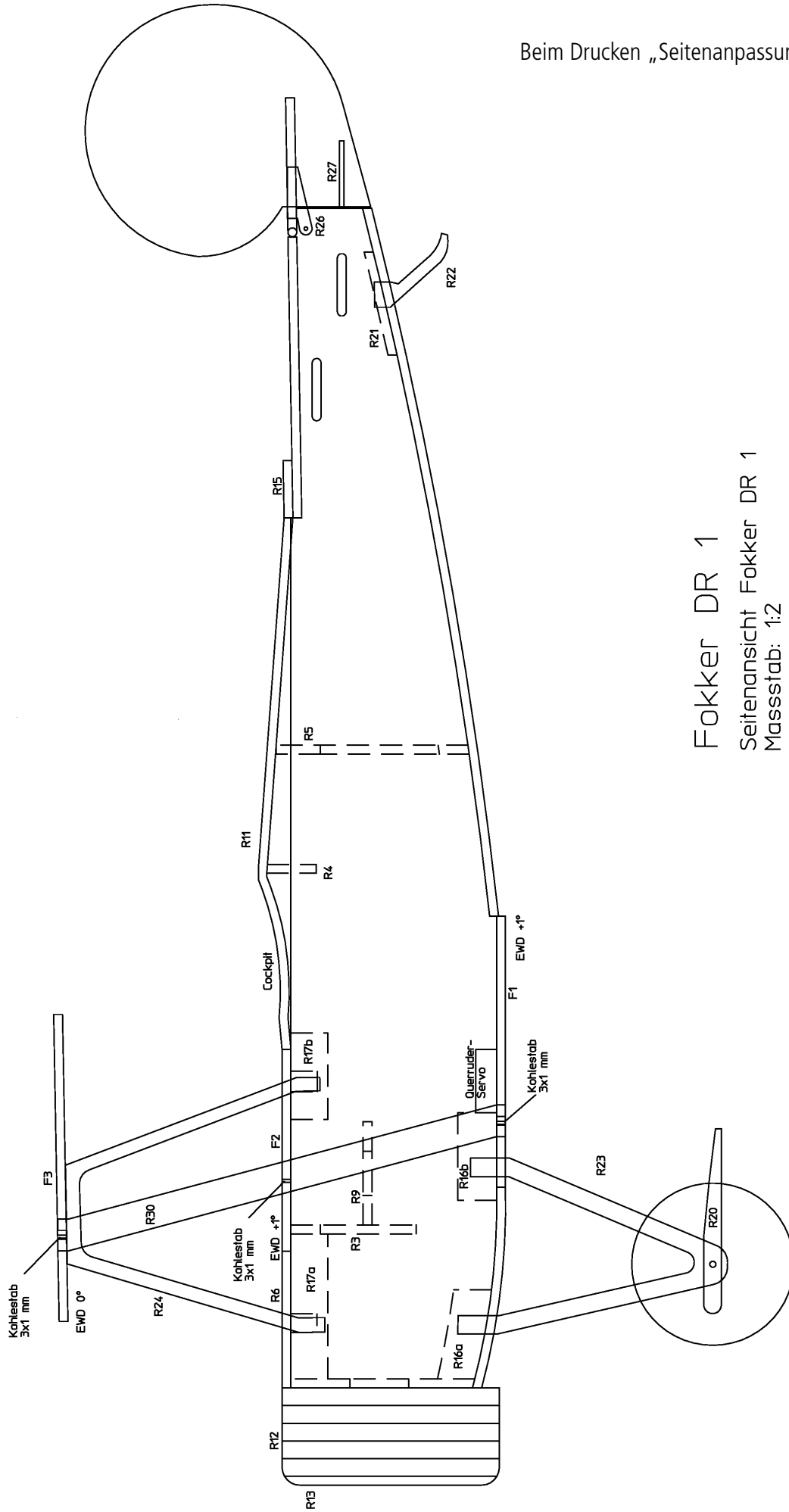

## Fokker DR 1

Seitenansicht Fokker DR 1  
Maßstab: 1:2

Konstruktion:  
Andreas Ahrens-Sander

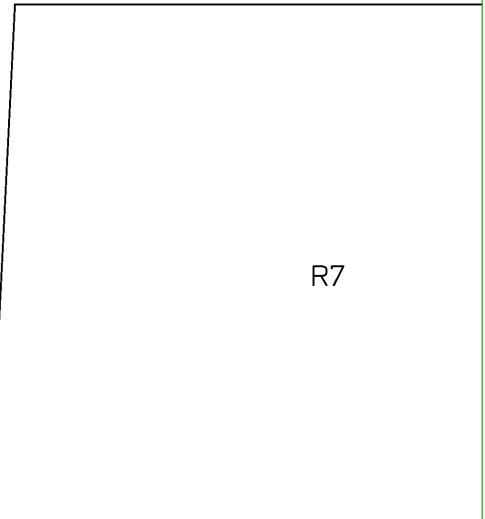
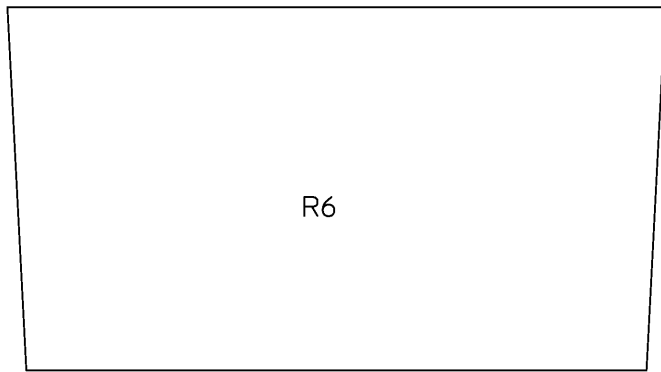
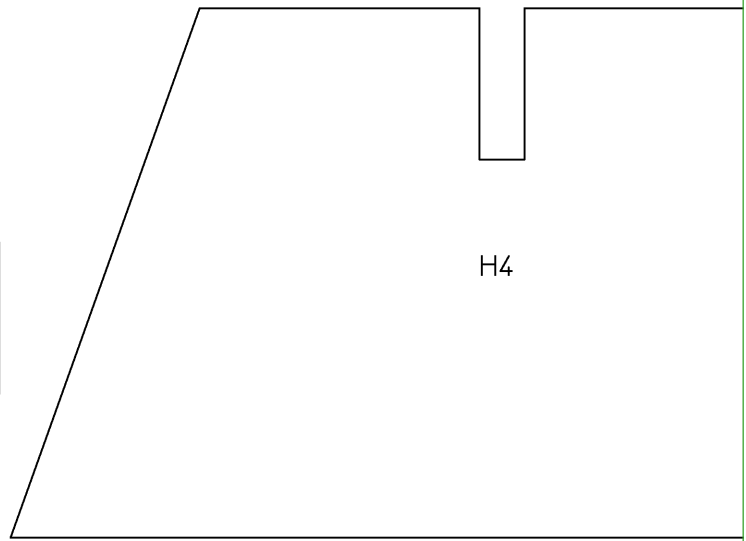
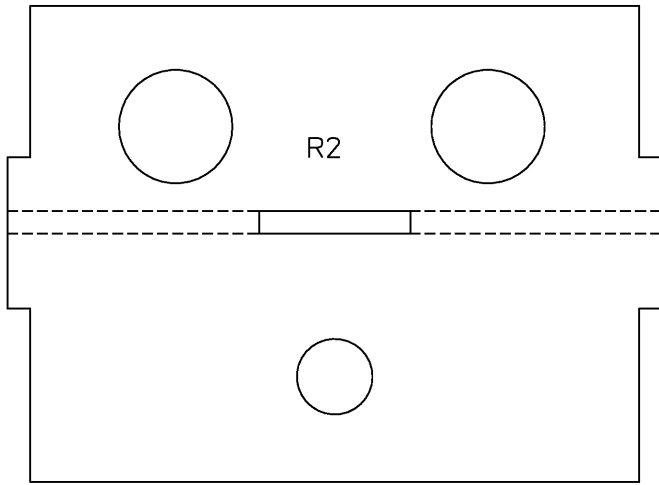
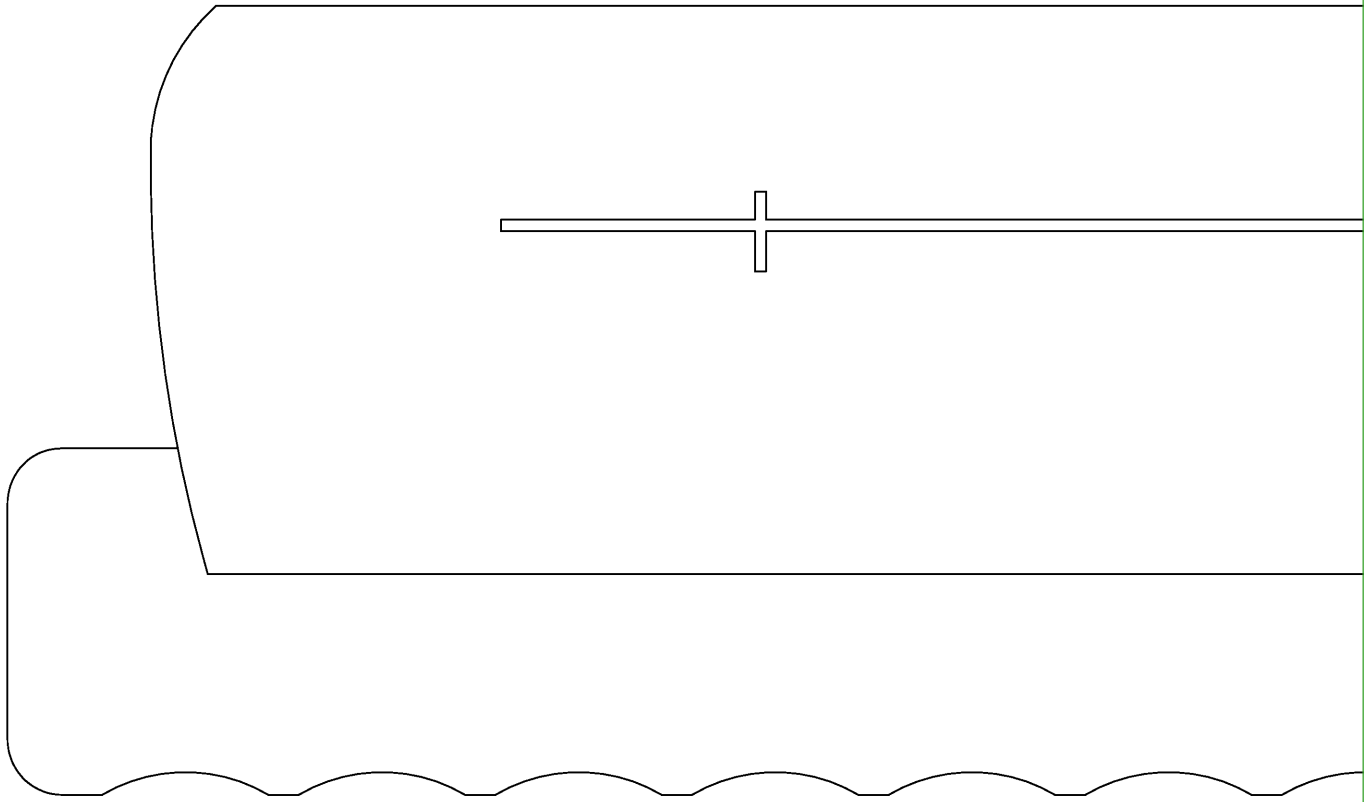
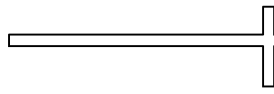

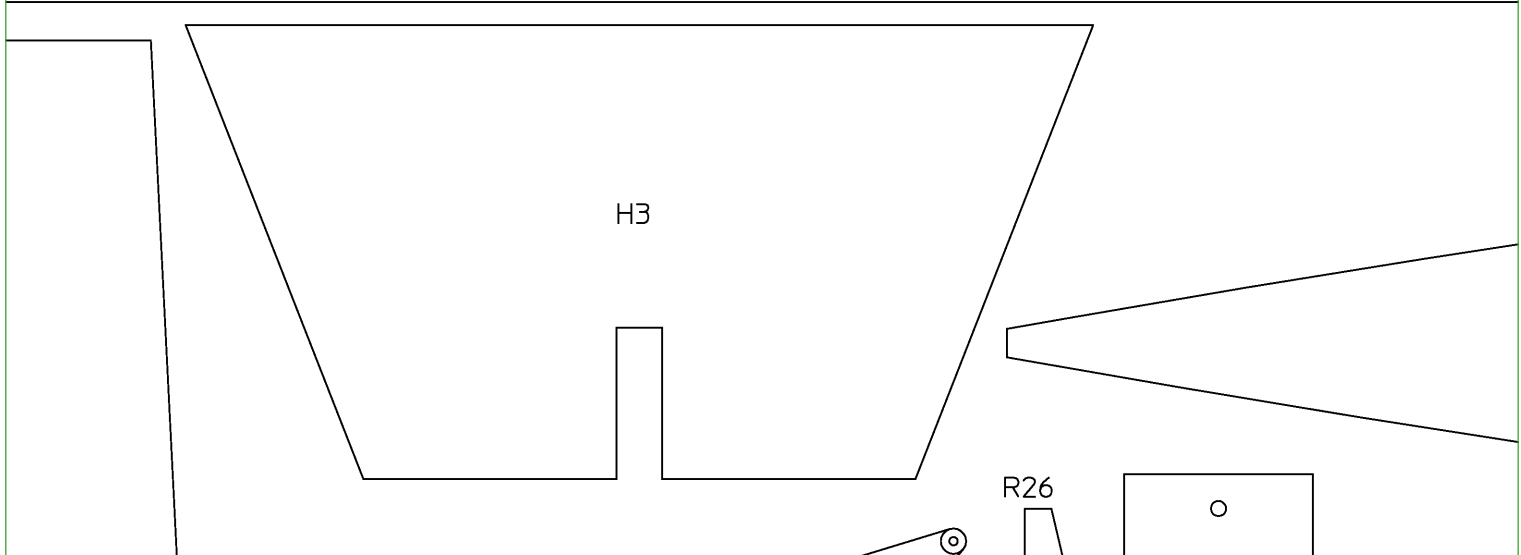
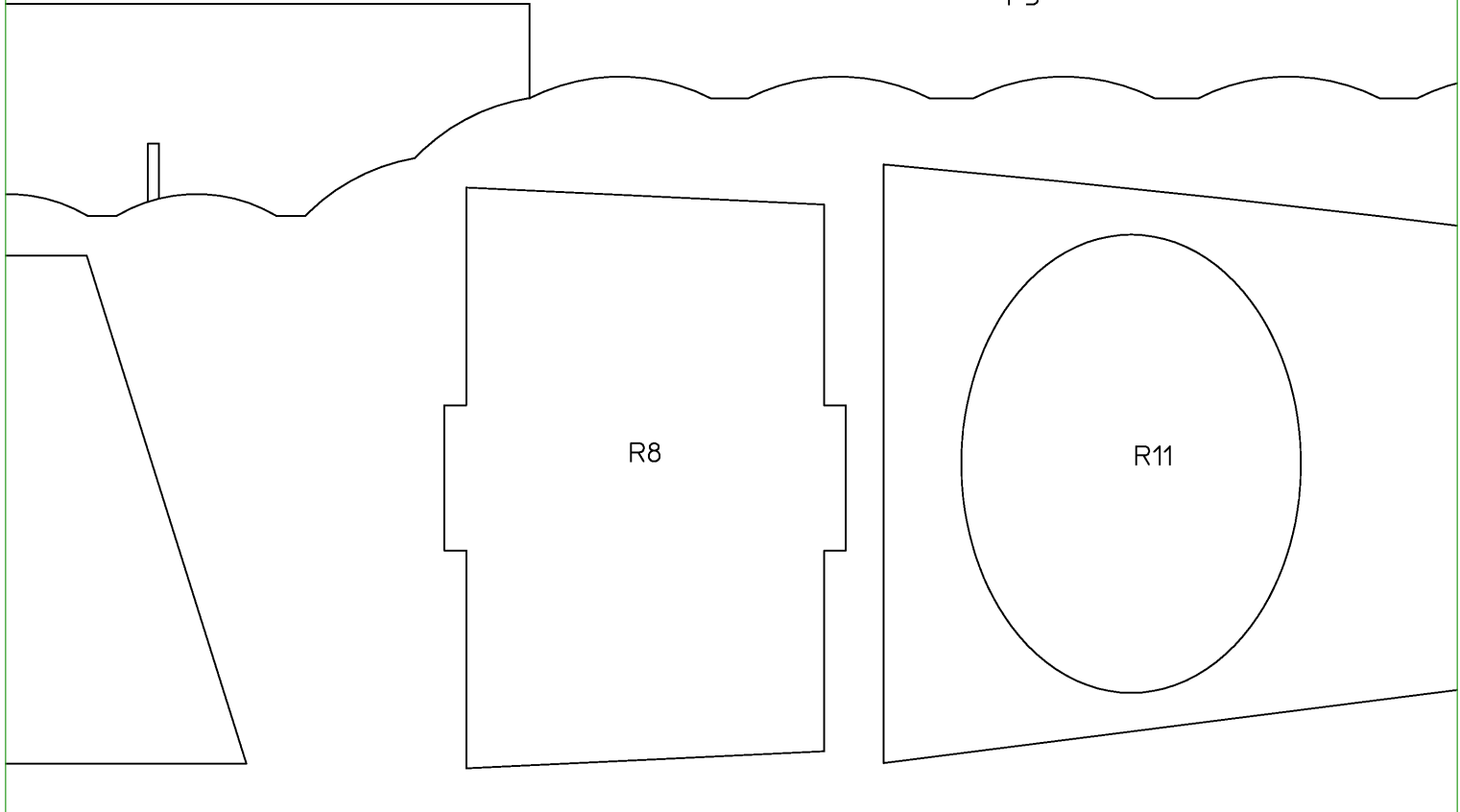
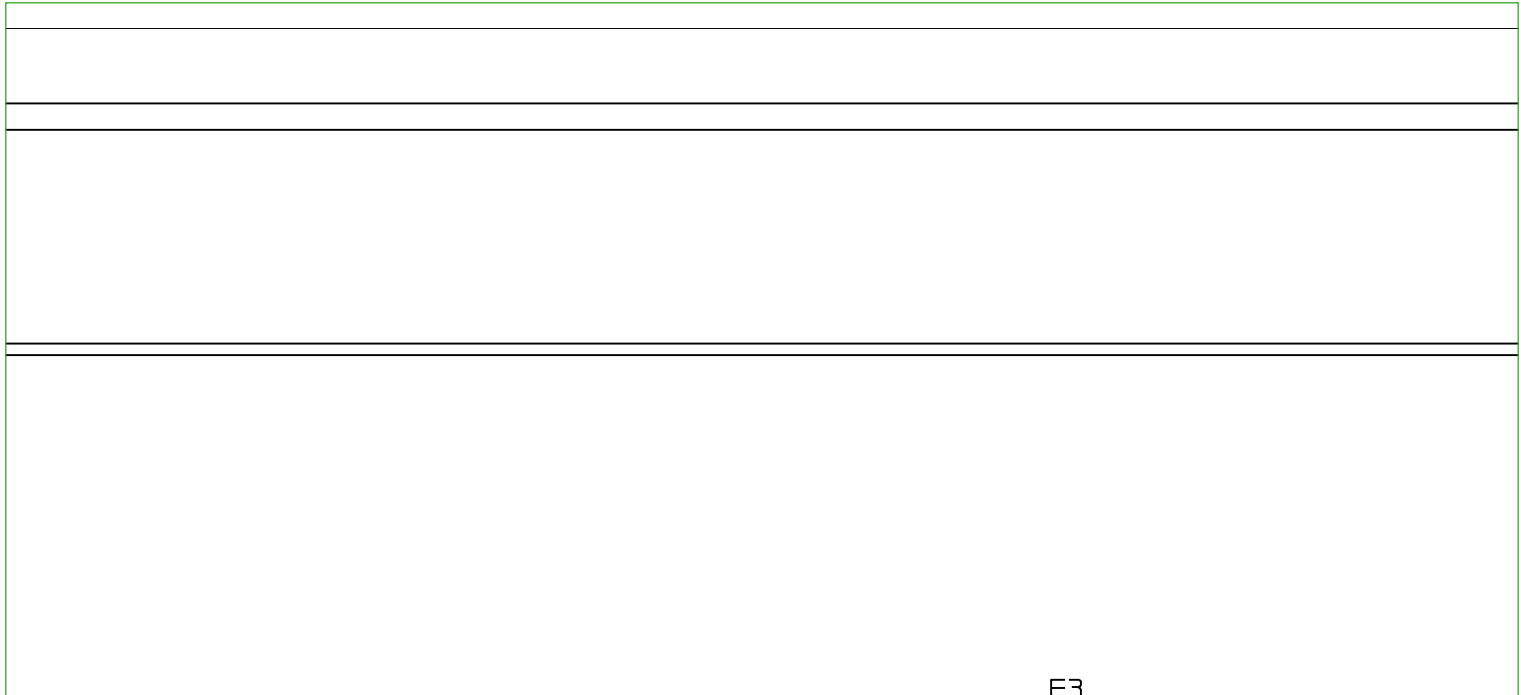

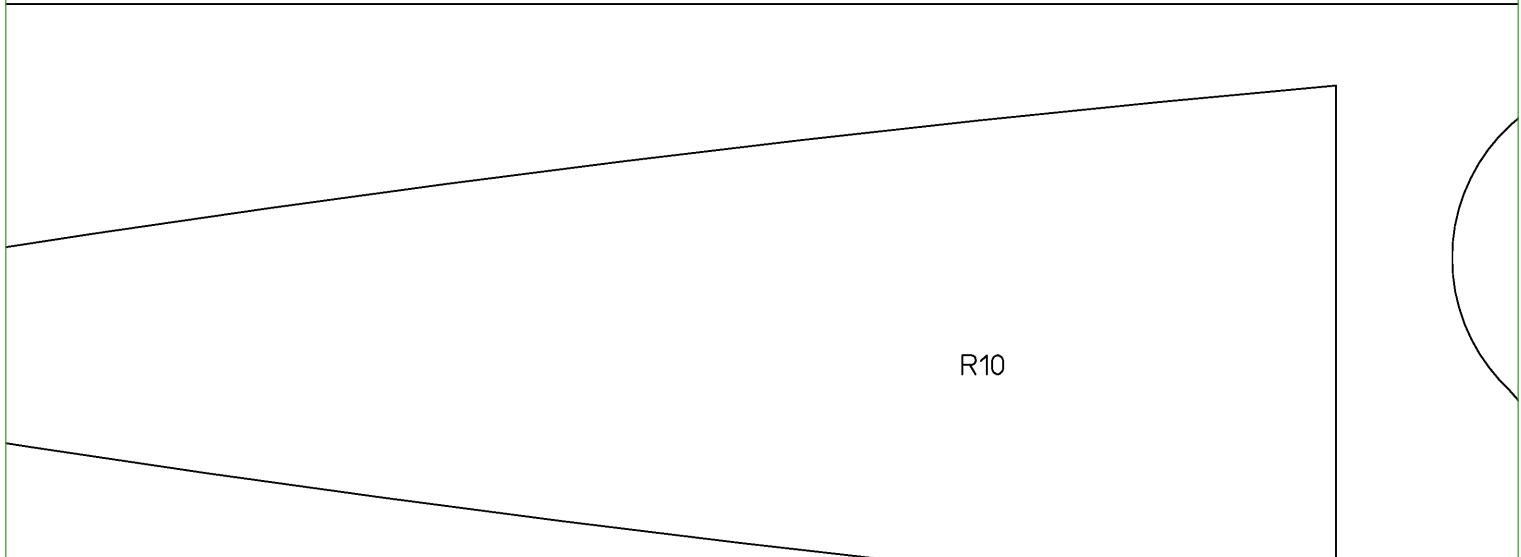
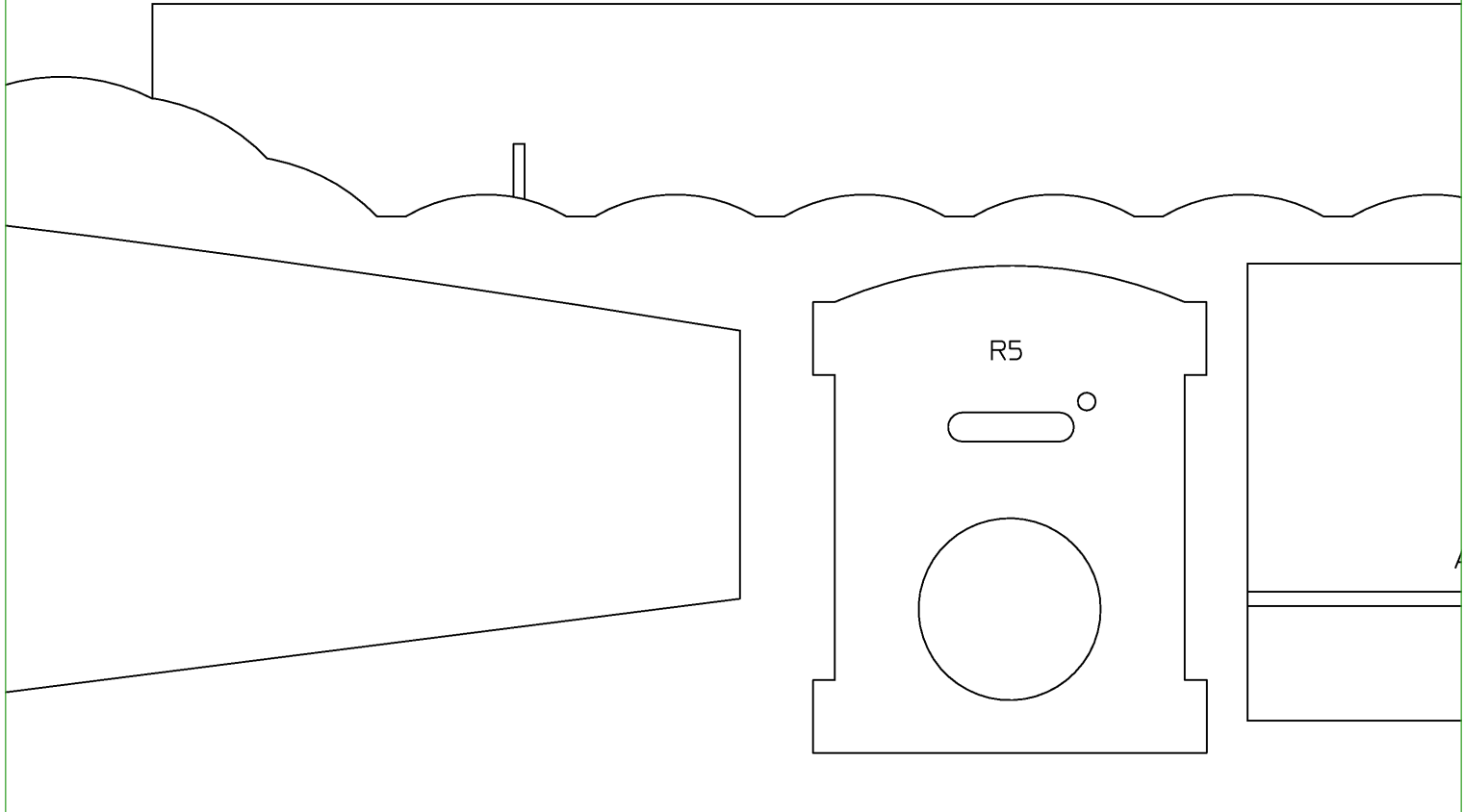
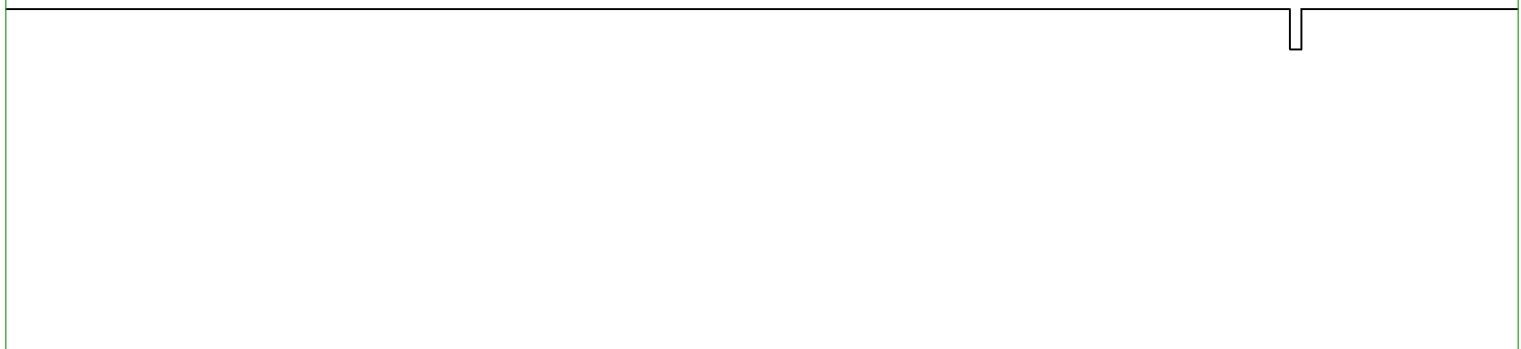
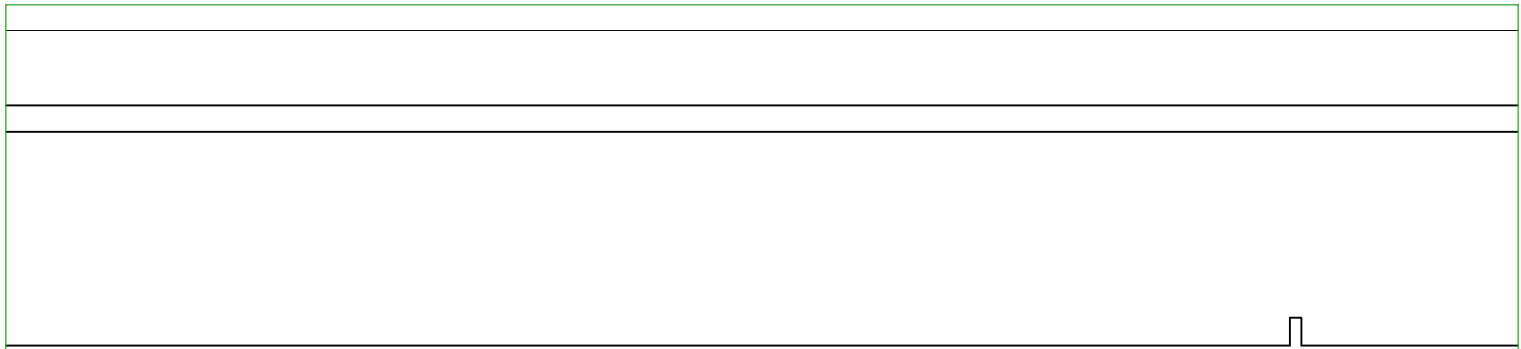

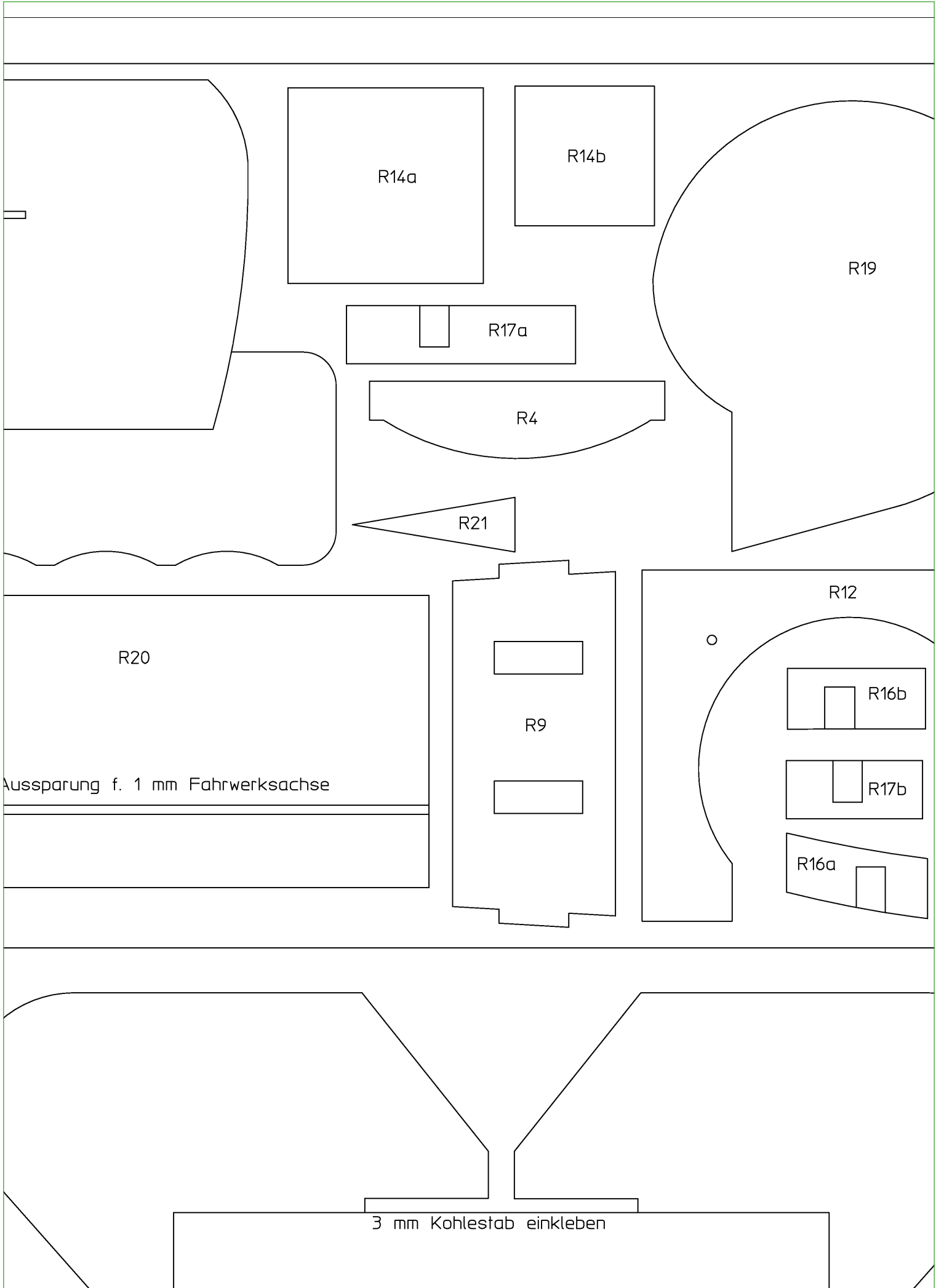

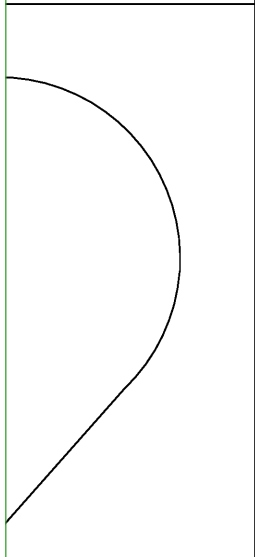
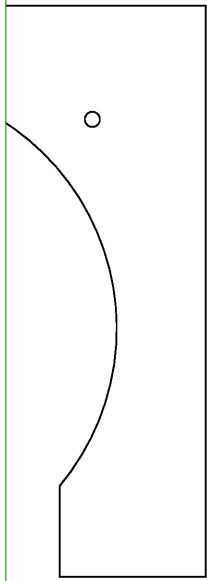
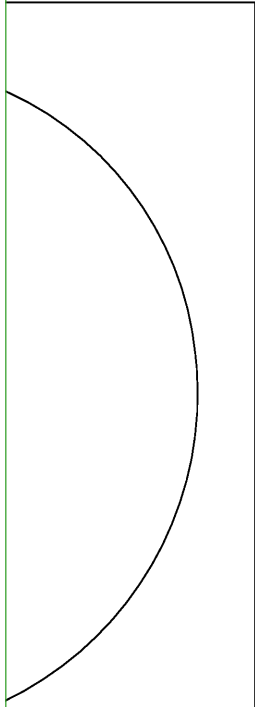



Aussparung f. Flächenstrebe



Aussparung f. Ruderhorn

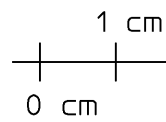

H2

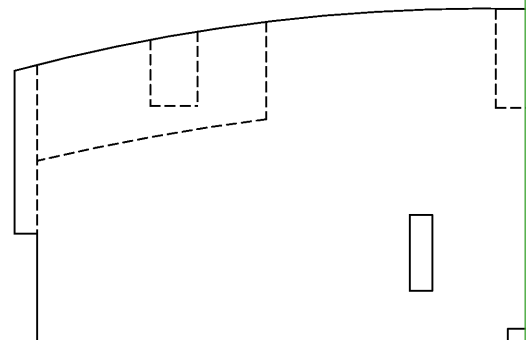



Schwerpunkt

Aussparung f. Kohlestab

F2

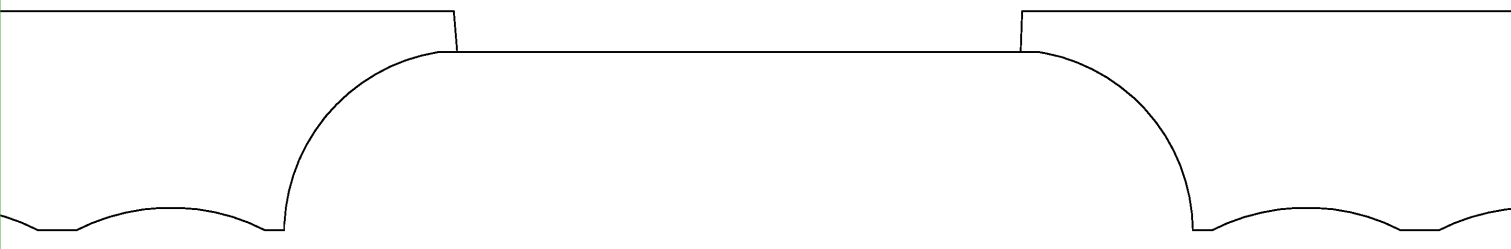

F1

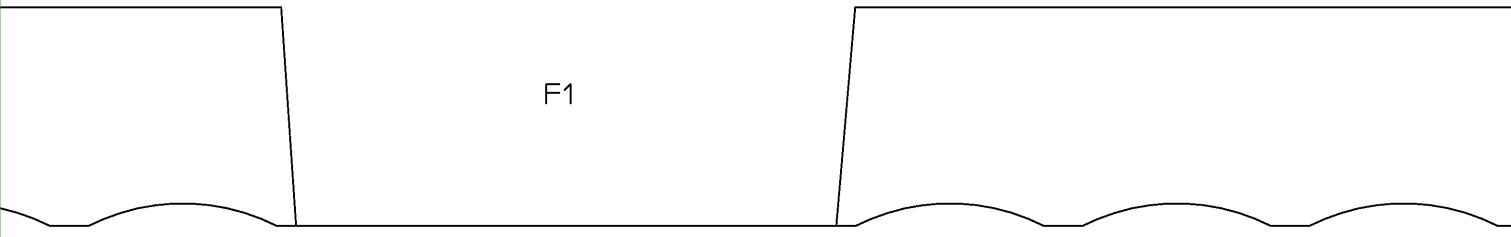

10 cm

Ende  
Untere Fläche

Querruder-  
Servo D 47

R1



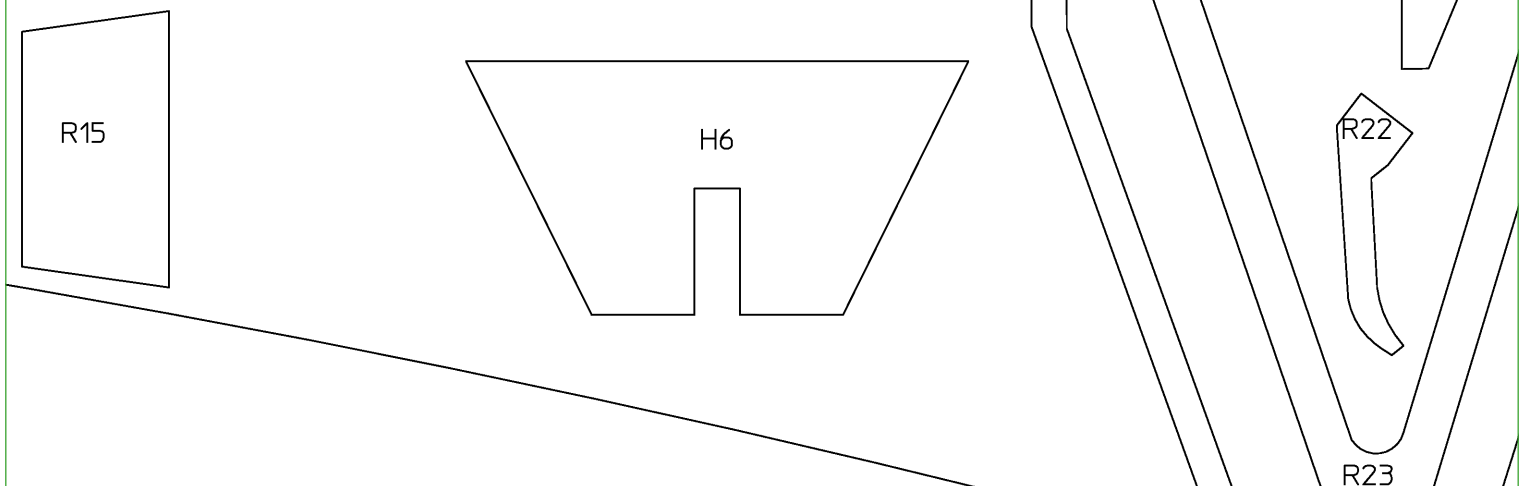
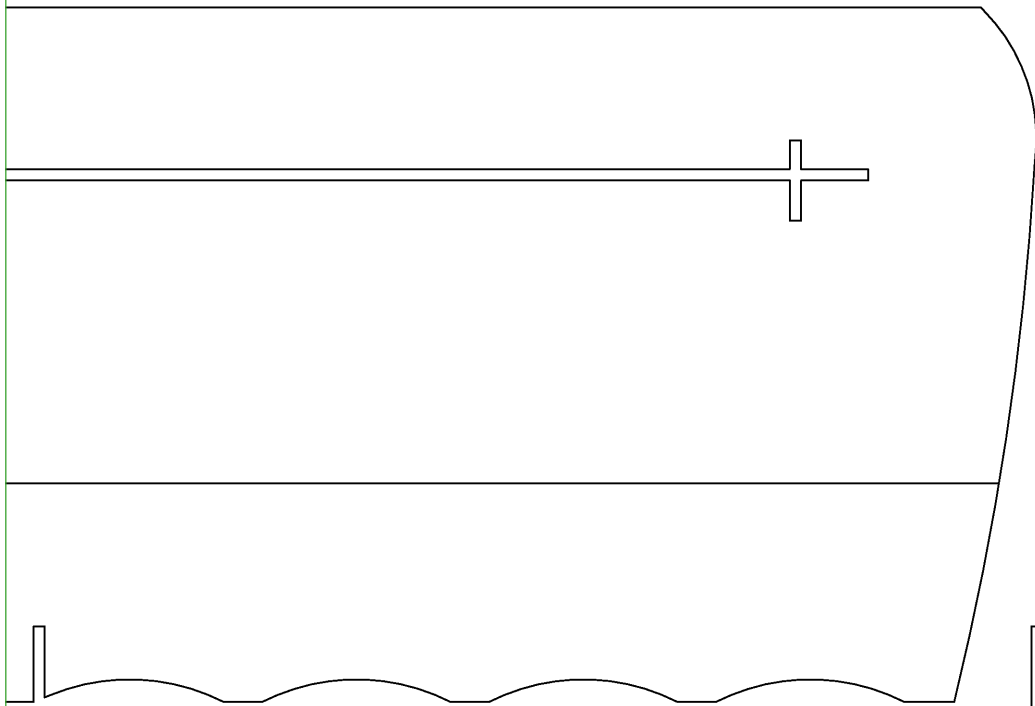
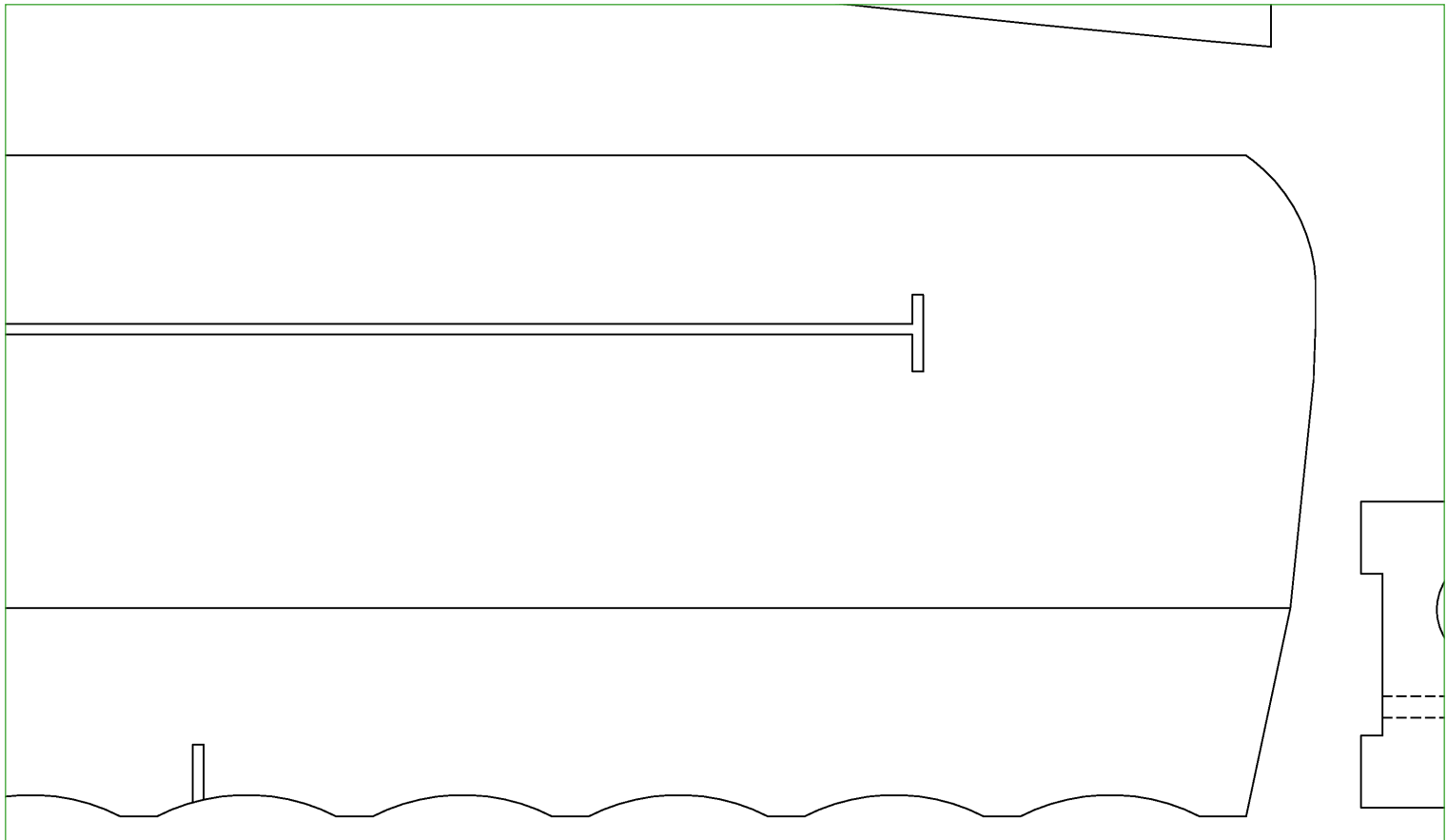

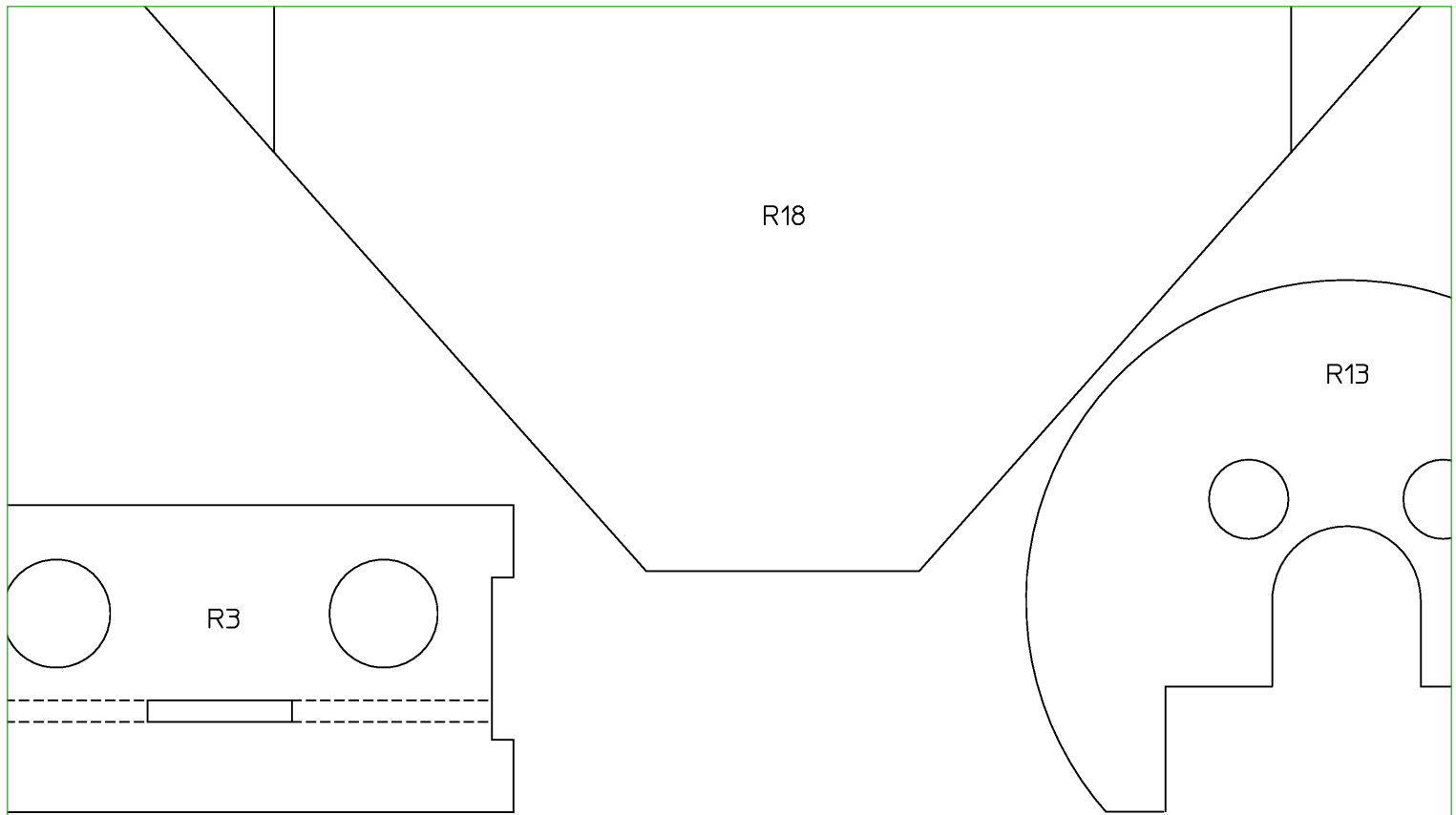

## Stückliste DR 1

- R1 Rumpfseitenwand, 3 mm, 2 x
- R2 Rumpfspannt 1, 3 mm, 1 x
- R3 Rumpfspannt 2, 3 mm, 1 x
- R4 Rumpfspannt 3, 3 mm, 1 x
- R5 Rumpfspannt 4, 3 mm, 1 x
- R6 Rumpfdeckel oben, 3 mm, 1 x
- R7 Rumpfboden, vorne, 3 mm, 1 x
- R8 Zwischenboden, 3 mm, 1 x
- R9 Servobrett, 3 mm, 1 x
- R10 Rumpfboden, hinten, unten, 3 mm, 1 x
- R11 Rumpfdeckel, hinten, oben, 3 mm, 1 x
- R12 Motorhaubenring, 6 mm, 5 x
- R13 Motorhauben Frontplatte, 3 mm, 1 x
- R14a Auffütterung Motorspant, 6 mm, 1 x (optional)
- R14b Auffütterung Motorspant, 6 mm, 1 x (optional)
- R15 Heckverkleidung (Auffütterung) 3 mm, 1 x
- R16a Verstärkung Fahrwerk, vorne, 6 mm, 2 x
- R16b Verstärkung Fahrwerk, hinten, 6 mm, 2 x
- R17a Verstärkung Baldachin, vorne, 6 mm, 2 x
- R17b Verstärkung Baldachin, hinten, 6 mm, 2 x
- R18 Höhenleitwerk, 3 mm, 1 x
- R19 Seitenleitwerk, 3 mm, 1 x
- R20 Fahrwerksverkleidung, 6 mm, 1 x
- R21 Verstärkung Hecksporn, 3 mm, 1 x
- R22 Hecksporn, Sperrholz o. GFK, 1,5 mm, 1 x
- R23 Fahrwerksstrebe, Sperrholz o. GFK, 1,5 mm, 2 x
- R24 Baldachinstrebe, Sperrholz o. GFK, 1,5 mm, 2 x
- R25 Ruderhorn Querruder, Sperrholz o. GFK, 1,5 mm, 6 x
- R26 HLW Ruderhorn, Sperrholz o. GFK, 1,5 mm, 1 x
- R27 SLW Ruderhorn, Sperrholz o. GFK, 1,5 mm, 1 x
- R28 Ruderhorn Querruder, Sperrholz o. GFK, 1,5 mm, 2 x
- R29 Motorträger, Sperrholz o. GFK, 1,5 mm, 1 x
- R30 Flächenstrebe, Sperrholz o. GFK, 1,5 mm, 2 x
- F1 Untere Tragfläche, 3 mm, 1 x
- F2 Mittlere Tragfläche, 3 mm, 1 x
- F3 Obere Tragfläche, 3 mm, 1 x

## Fokker DR 1

Spannweite: 65 cm  
 Länge: 50 cm  
 Gewicht: 170g (ohne Motor: Dymond AL 2  
 Regler: Dymond Sma  
 Akku: Dymond 2 S1F  
 Luftschr.: 8x4,3"

Servos:  
 Querruder 2 Dymond  
 HLW: Dymond D 37e  
 SLW: Dymond D 37e

Einstellwerte:  
 Untere Tragfläche: +  
 Mittlere Tragfläche:  
 Obere Tragfläche: 0  
 HLW: 0°

Einstellwerte Ruder:  
 SLW: max. Ausschlag  
 HLW: +/- 25 mm  
 Querruder: +/- 10 mm

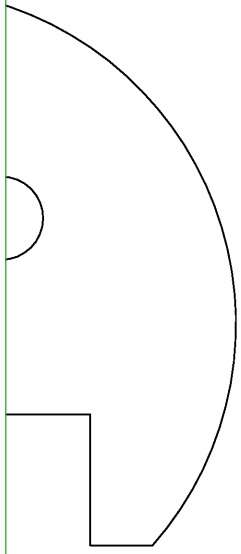

(Farbe)  
2211  
rt 10  
P 600 mAh

D 47  
CO  
CO

+1°  
+1°  
°

g

m

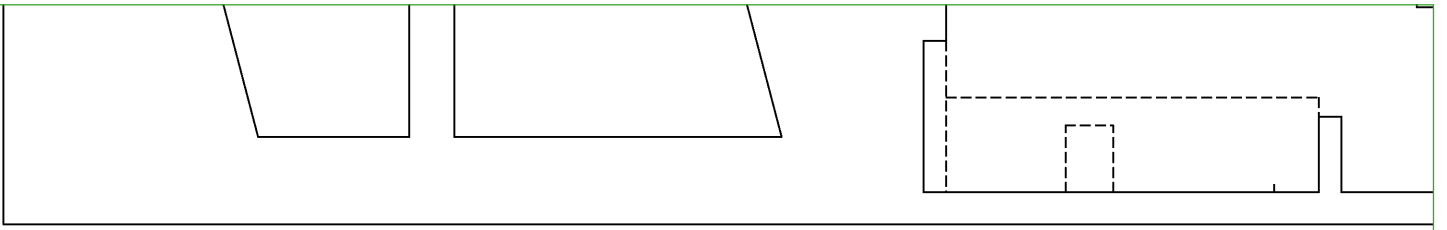

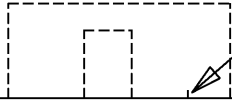

Ende  
Mittl. Fläche



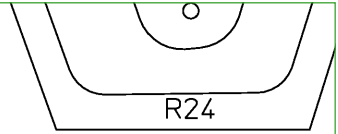
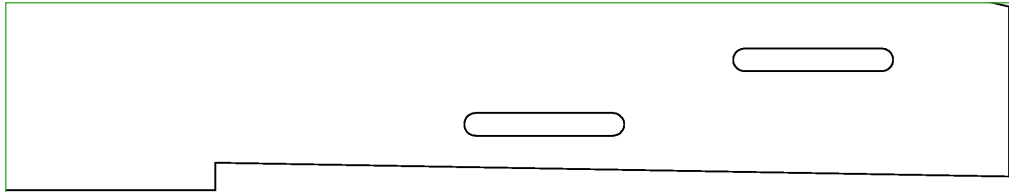

- H1 Stützfüße, 6 mm, 5 x
- H2 Schablone Tragfläche Abstände, 6 mm, 2 x
- H3 Schablone Fahrwerksbeine, 6 mm, 1 x
- H4 Schablone Baldachin, 6 mm, 2 x

Konstruktion:  
Andreas Ahrens-

